

# Silenziatori in acciaio per auto

**00.110.01**

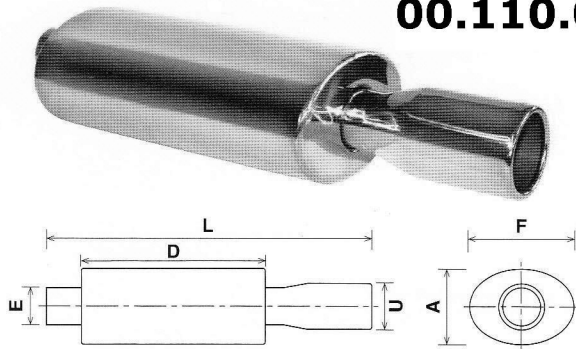

Dimensioni/Dimensions				
	E	F x A x D	L	U
mm.	58	203x127x355	622	100

**00.110.02**

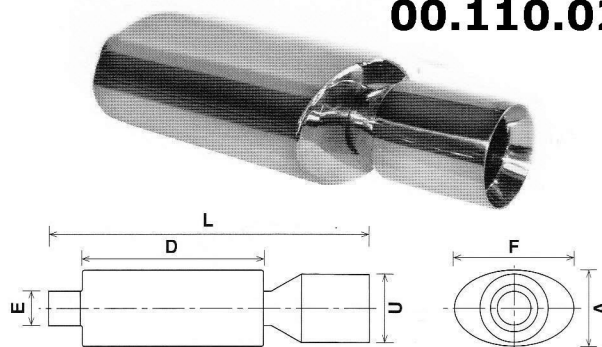

Dimensioni/Dimensions				
	E	F x A x D	L	U
mm.	58	203x127x305	540	100

**00.110.03**

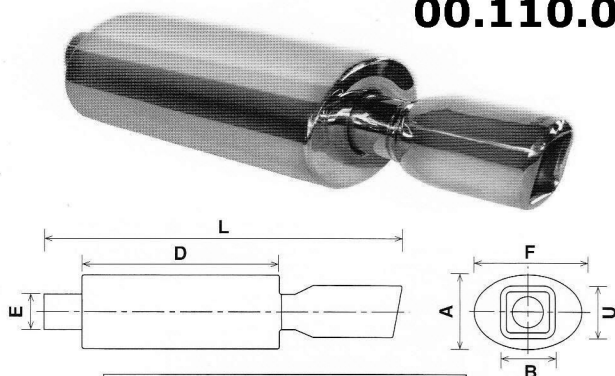

Dimensioni/Dimensions					
	E	F x A x D	L	U	B
mm.	58	203x127x355	635	90	97

**00.110.04**

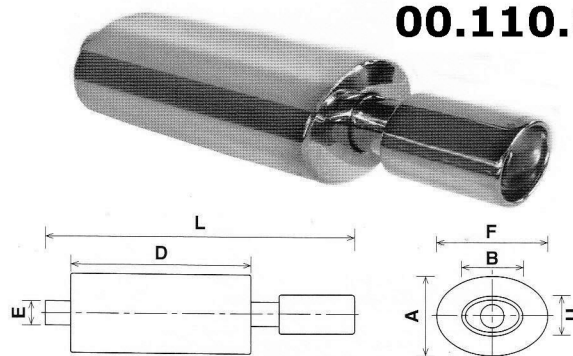

Dimensioni/Dimensions					
	E	F x A x D	L	U	B
mm.	58	203x127x355	610	83	120

**00.110.05**

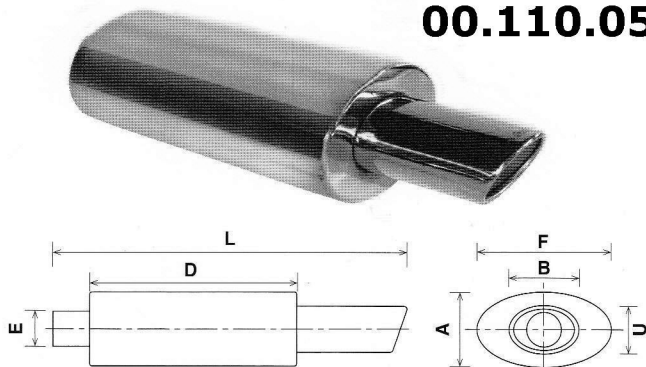

Dimensioni/Dimensions					
	E	F x A x D	L	U	B
mm.	52	203x127x355	570	70	105

**00.110.06**

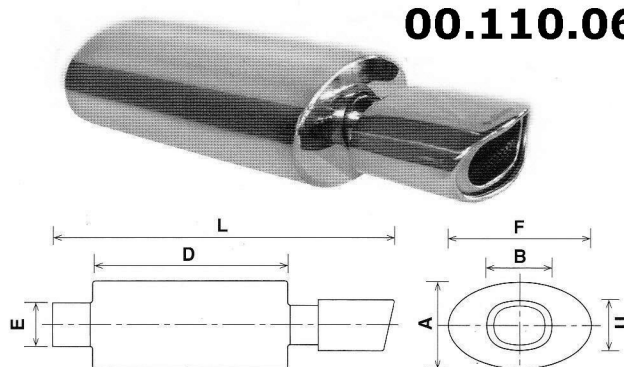

Dimensioni/Dimensions					
	E	F x A x D	L	U	B
mm.	58	203x127x355	585	75	143

**00.110.07**

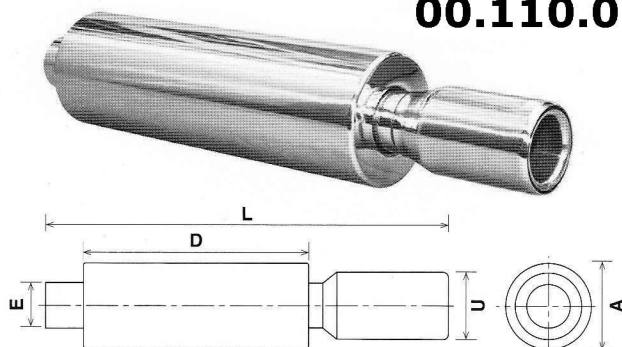

Dimensioni/Dimensions				
	E	D x A	L	U
mm.	58	400x127	620	76

**00.110.08**

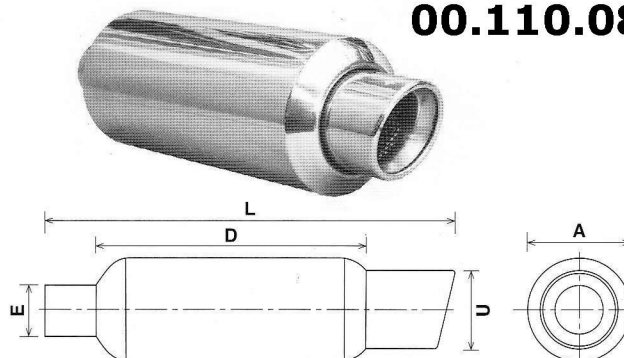

Dimensioni/Dimensions					
	E	U	D	L	A
mm.	58	89	300	460	140

### 00.110.10

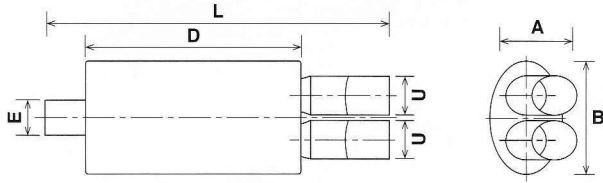
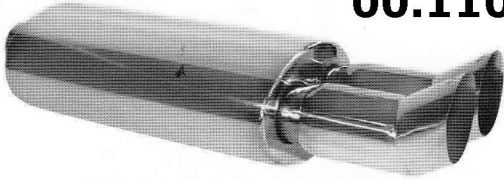

Dimensioni/Dimensions				
	E	B x A x D	L	U
mm.	58	203x127x355	600	76

### 00.110.11

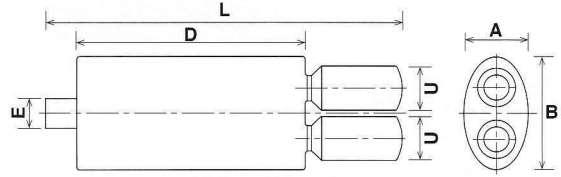
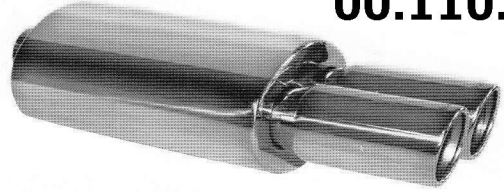

Dimensioni/Dimensions				
	E	B x A x D	L	U
mm.	58	203x127x305	533	76

### 00.110.12 (CARBONIO)

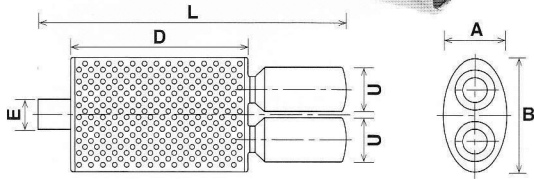
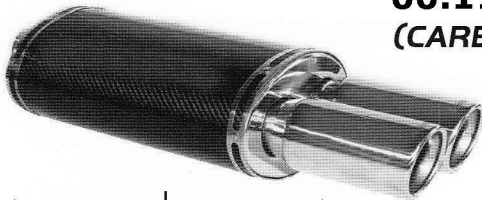

Dimensioni/Dimensions				
	E	B x A x D	L	U
mm.	58	203x127x355	600	76

### 00.110.13

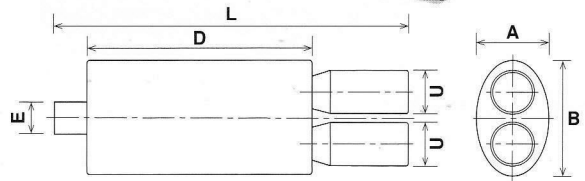
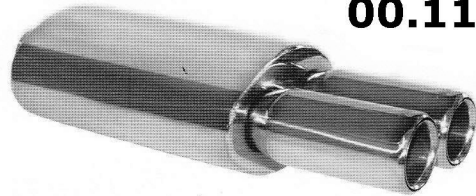

Dimensioni/Dimensions				
	E	B x A x D	L	U
mm.	58	203x127x305	533	76

# Terminali in acciaio universali

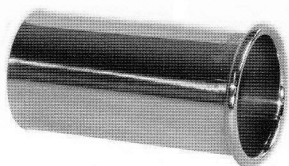

**00.110.30**  
**00.110.31**  
**00.110.32**  
**00.110.33**

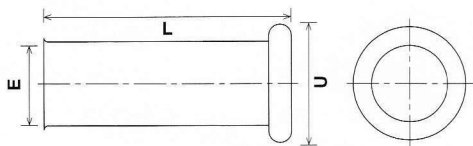

**00.110.30**   **00.110.31**   **00.110.32**   **00.110.33**

Dimensioni/Dimensions			
E	U	L	
mm. 42	54	100	

Dimensioni/Dimensions			
E	U	L	
mm. 51	64	96	

Dimensioni/Dimensions			
E	U	L	
mm. 46	60	130	

Dimensioni/Dimensions			
E	U	L	
mm. 61	72	130	

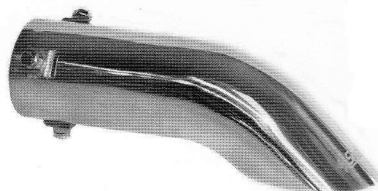

**00.110.34**  
**00.110.35**  
**00.110.36**

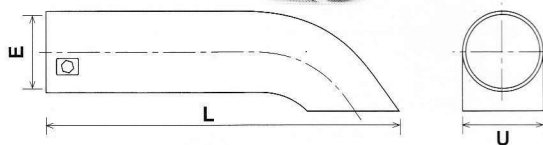

**00.110.34**   **00.110.35**   **00.110.36**

Dimensioni/Dimensions			
E	U	L	
mm. 40	42	203	

Dimensioni/Dimensions			
E	U	L	
mm. 46	48	203	

Dimensioni/Dimensions			
E	U	L	
mm. 55	57	203	

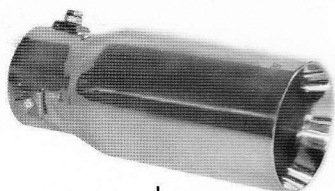

**00.110.37**

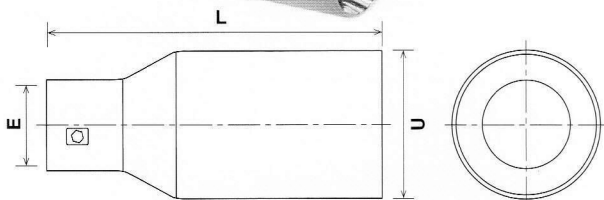

Dimensioni/Dimensions			
E	U	L	
mm. 58	76	178	

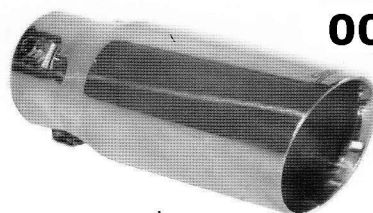

**00.110.38**

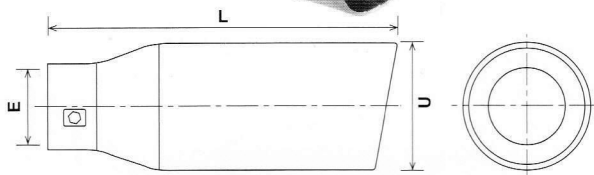

Dimensioni/Dimensions			
E	U	L	
mm. 64	82	203	

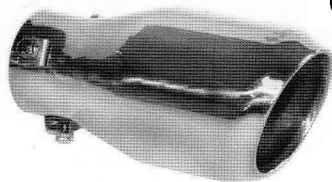

**00.110.39**

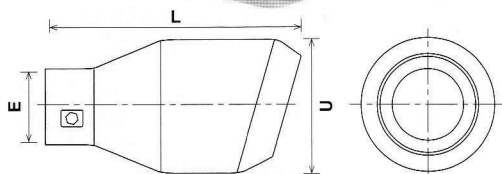

Dimensioni/Dimensions			
E	U	L	
mm. 58	89	178	

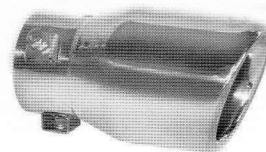

**00.110.40**

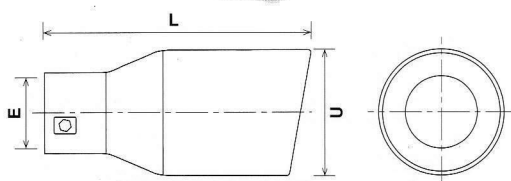

Dimensioni/Dimensions			
E	U	L	
mm. 54	76	140	

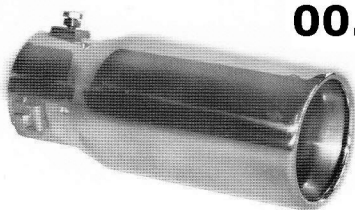

**00.110.41**

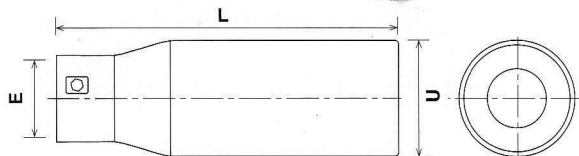

Dimensioni/Dimensions			
E	U	L	
mm. 58	76	178	

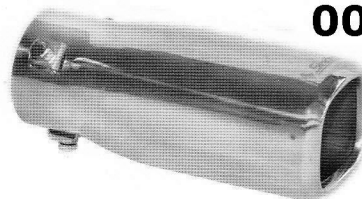

**00.110.42**

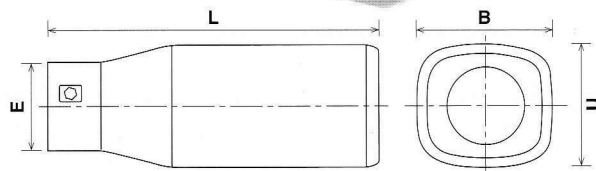

Dimensioni/Dimensions			
E	B x U	L	
mm. 61	80x70	174	

**00.110.43**

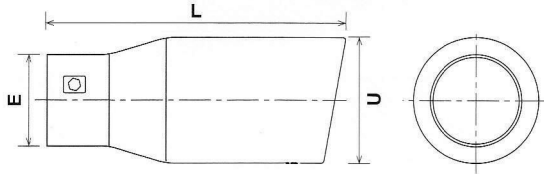
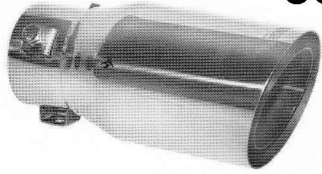

Dimensioni/Dimensions			
	E	U	L
mm.	54	76	165

**00.110.44**

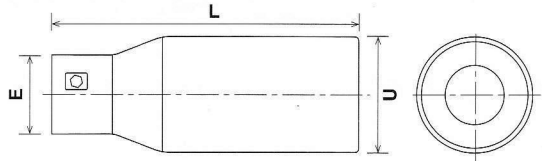
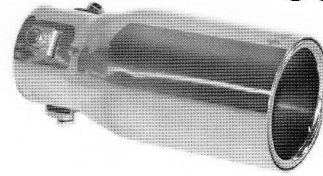

Dimensioni/Dimensions			
	E	U	L
mm.	54	76	165

**00.110.45**

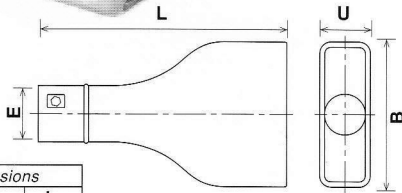
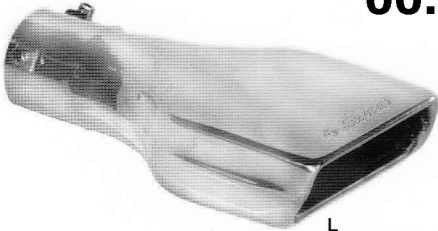

Dimensioni/Dimensions			
	E	B x U	L
mm.	64	152x51	254

**00.110.46**

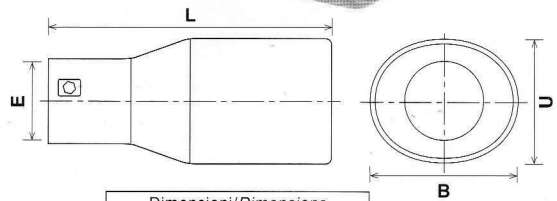
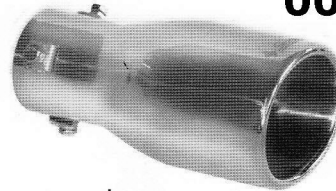

Dimensioni/Dimensions			
	E	B x U	L
mm.	58	95x78	178

**00.110.47**  
**00.110.48**

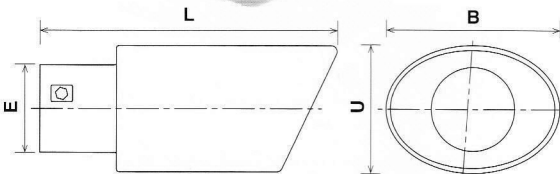
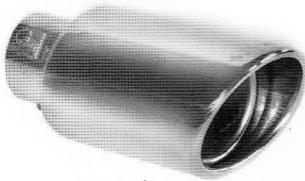

Dimensioni/Dimensions			
	E	B x U	L
mm.	52	102x80	178

Dimensioni/Dimensions			
	E	B x U	L
mm.	58	102x80	178

**00.110.49**

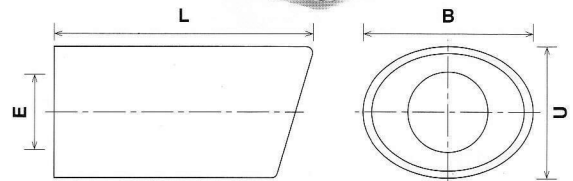
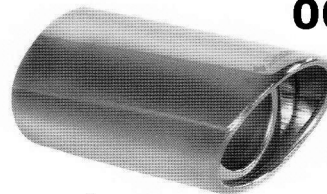

Dimensioni/Dimensions			
	E	B x U	L
mm.	58	117x85	160

**00.110.50**

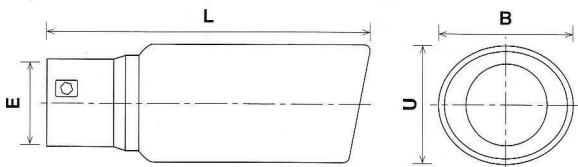
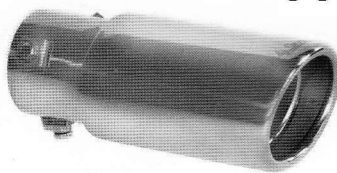

Dimensioni/Dimensions			
	E	B x U	L
mm.	58	84x70	178

**00.110.51**

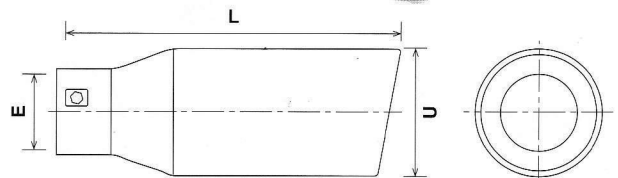
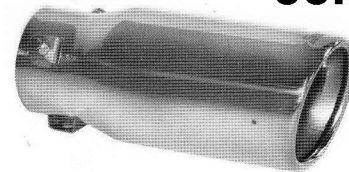

Dimensioni/Dimensions			
	E	U	L
mm.	58	76	178

**00.110.52**  
(CARBONIO)  
(SILENZIATO)

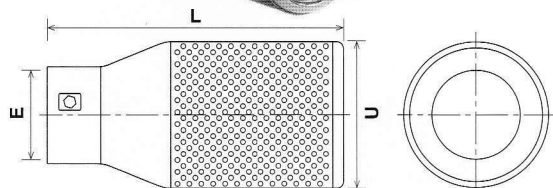

Dimensioni/Dimensions			
	E	U	L
mm.	58	89	178

**00.110.53**

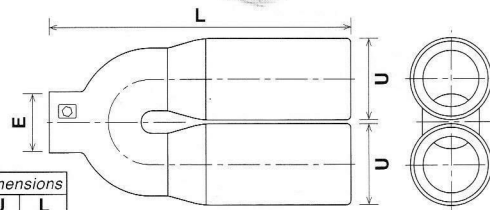
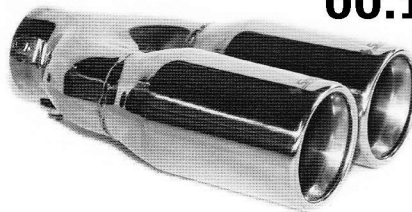

Dimensioni/Dimensions			
	E	U	L
mm.	58	76	240

**00.110.54**

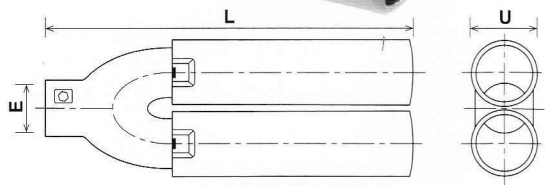
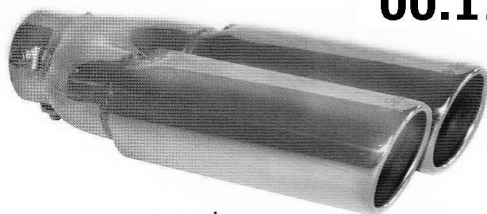

Dimensioni/Dimensions			
	E	U	L
mm.	58	70	294

**00.110.55**

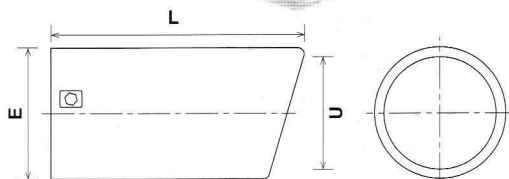
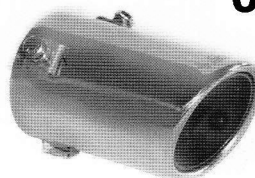

Dimensioni/Dimensions			
	E	U	L
mm.	61	63	112

**00.110.56**

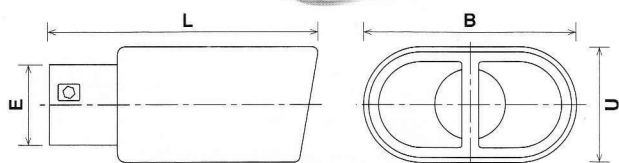
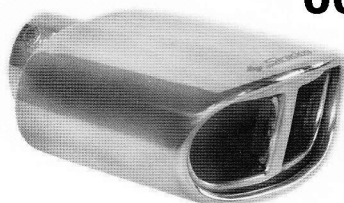

Dimensioni/Dimensions			
	E	B x U	L
mm.	54	144x75	180

**00.110.57**

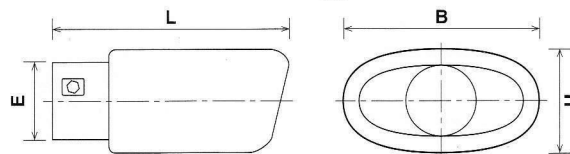
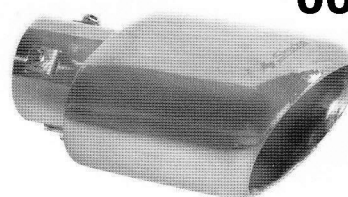

Dimensioni/Dimensions			
	E	B x U	L
mm.	58	150x78	178

**00.110.58**

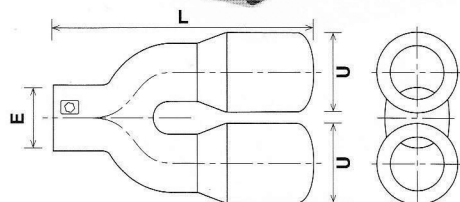
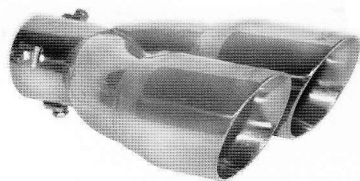

Dimensioni/Dimensions			
	E	U	L
mm.	58	76	230

**00.110.59 DX**

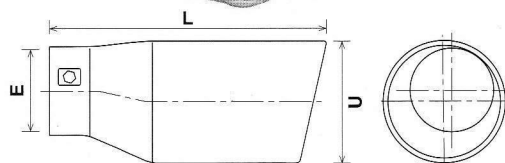
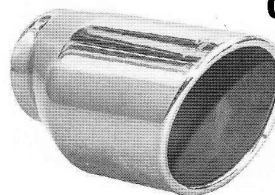

Dimensioni/Dimensions			
	E	U	L
mm.	48	70	145

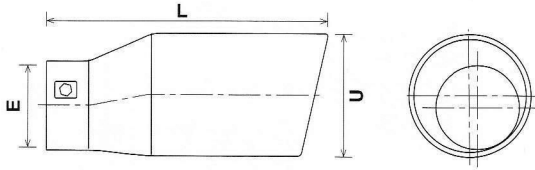
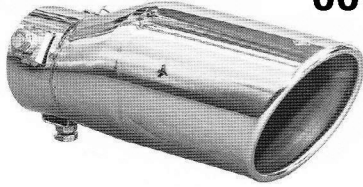
**00.110.60 SX**

Dimensioni/Dimensions			
	E	U	L
mm.	48	70	169

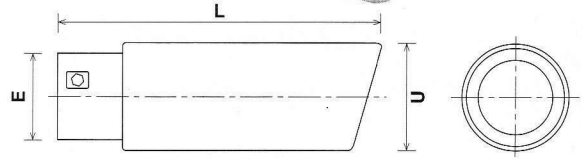
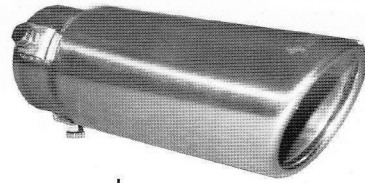
**00.110.61**

Dimensioni/Dimensions			
	E	U	L
mm.	50	60	170

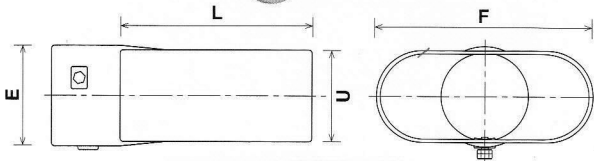
**00.110.62**

Dimensioni/Dimensions				
	E	F	U	L
mm.	46	110	46	75

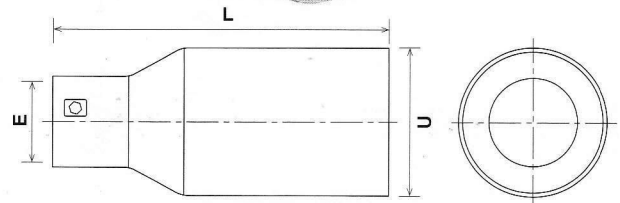
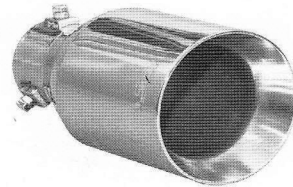
**00.110.63**

Dimensioni/Dimensions			
	E	U	L
mm.	58	102	178

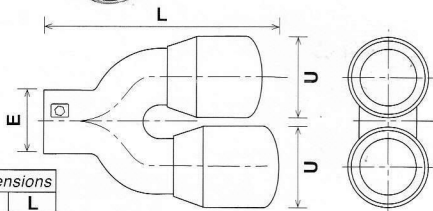
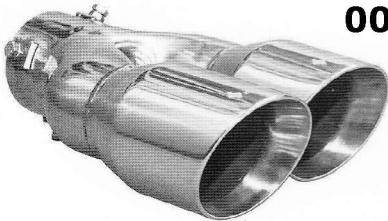
**00.110.64 DX**

Dimensioni/Dimensions			
	E	U	L
mm.	58	76	245

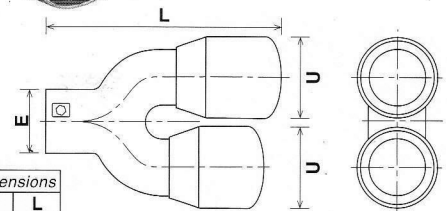
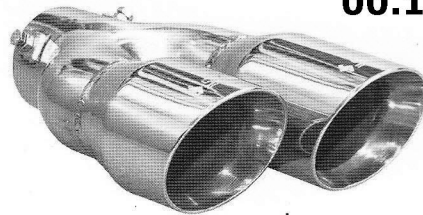
**00.110.65 SX**

Dimensioni/Dimensions			
	E	U	L
mm.	58	76	245

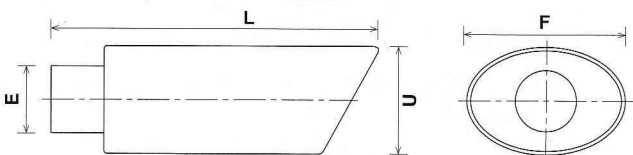
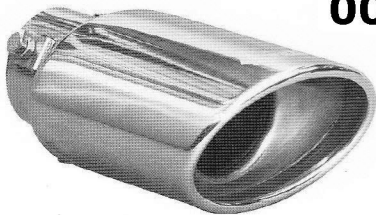
**00.110.66**

Dimensioni/Dimensions				
	E	F	U	L
mm.	52	107	70	165

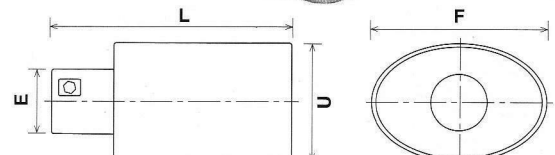
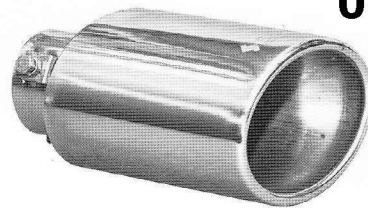
**00.110.67**

Dimensioni/Dimensions				
	E	F	U	L
mm.	58	120	80	170

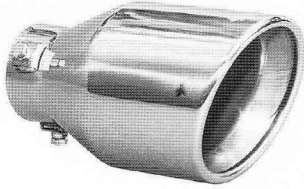

**00.110.68**

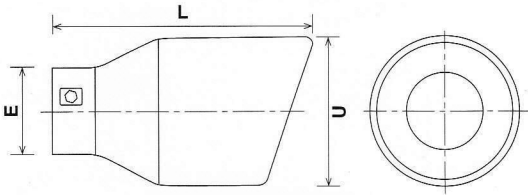

Dimensioni/Dimensions				
	E	U	L	
mm.	58	101	178	

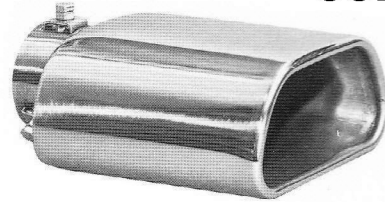

**00.110.69**

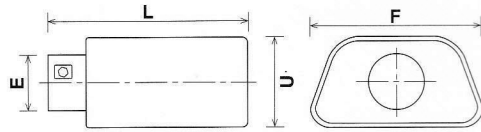

Dimensioni/Dimensions				
	E	F	U	L
mm.	58	140	70	158



**00.110.70**  
**(SILENZIATO)**

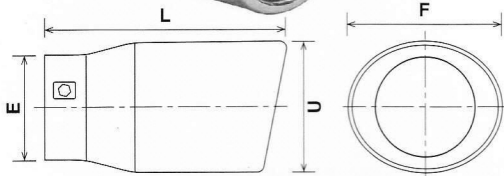

Dimensioni/Dimensions				
	E	F	U	L
mm.	64	95	84	145

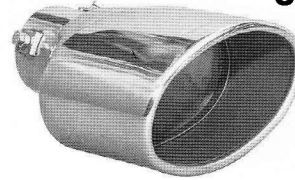

**00.110.71 DX**

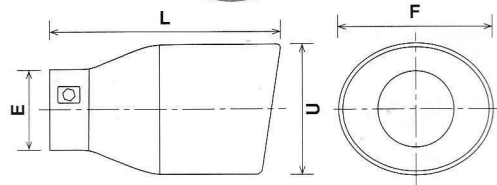

Dimensioni/Dimensions				
	E	F	U	L
mm.	58	152	95	203

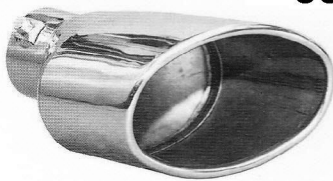

**00.110.72 SX**

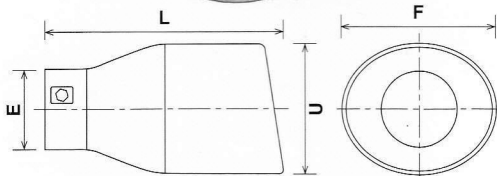

Dimensioni/Dimensions				
	E	F	U	L
mm.	58	152	95	203

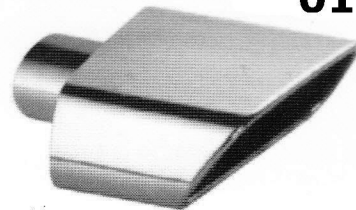

**01.110.73**

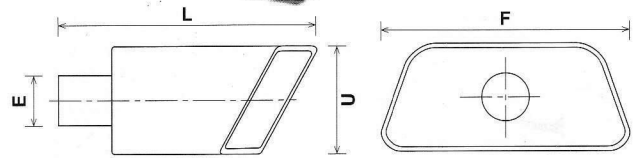

Dimensioni/Dimensions				
	E	F	U	L
mm.	51	147	60	148



**00.110.74 DX**

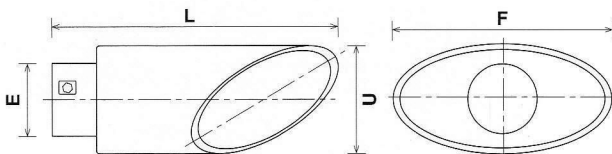

Dimensioni/Dimensions				
	E	F	U	L
mm.	58	130	70	197

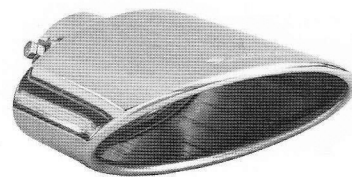

**01.110.75 SX**

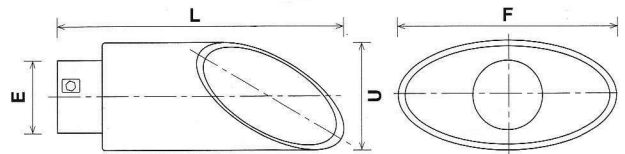

Dimensioni/Dimensions				
	E	F	U	L
mm.	58	130	70	197

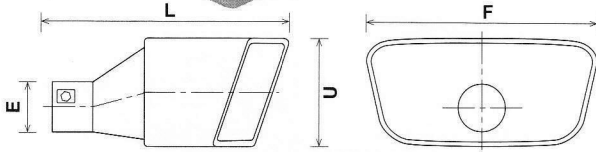
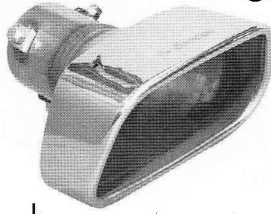
**00.110.76 DX**

Dimensioni/Dimensions				
	E	F	U	L
mm.	58	175	90	197

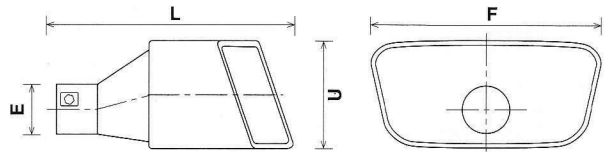
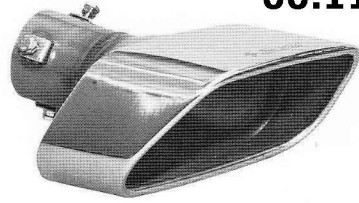
**00.110.77 SX**

Dimensioni/Dimensions				
	E	F	U	L
mm.	58	175	90	197

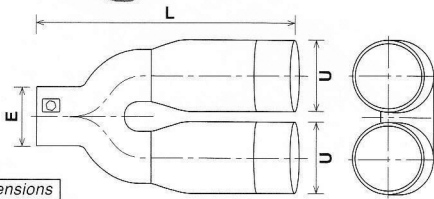
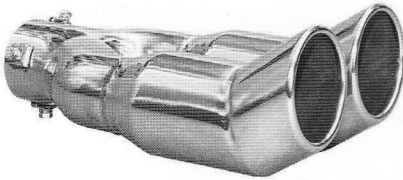
**00.110.78**

Dimensioni/Dimensions			
	E	U	L
mm.	58	76	280

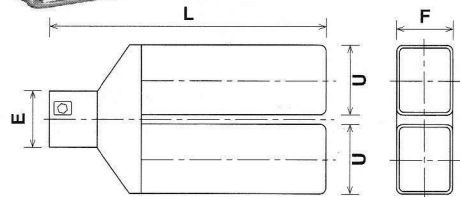
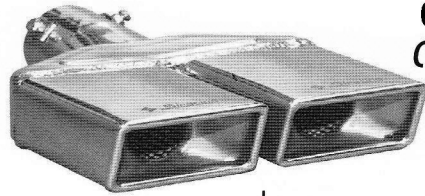
**00.110.79  
(SILENZIATO)**

Dimensioni/Dimensions				
	E	F	U	L
mm.	58	54	97	254

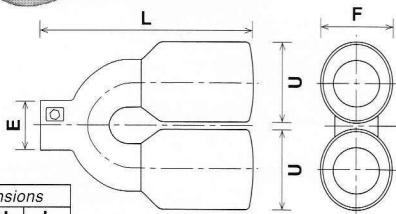
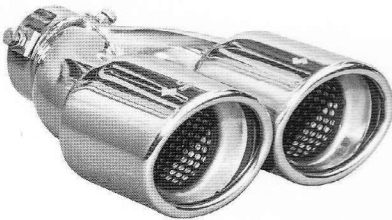
**00.110.80  
(SILENZIATO)**

Dimensioni/Dimensions				
	E	F	U	L
mm.	52	70	83	210

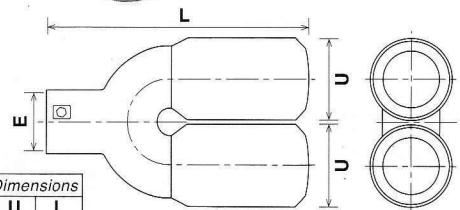
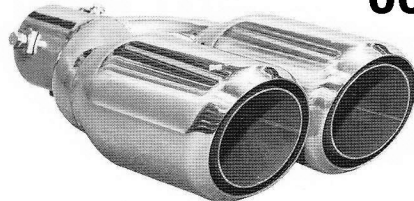
**00.110.81**

Dimensioni/Dimensions			
	E	U	L
mm.	58	89	315

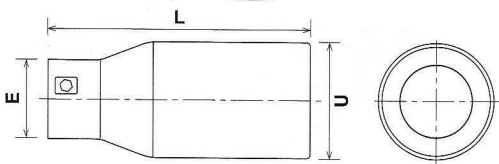
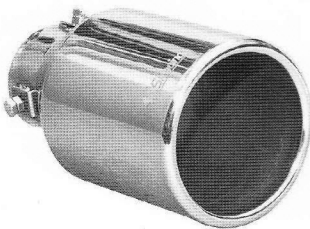
**01.110.82**

Dimensioni/Dimensions			
	E	U	L
mm.	58	101	178

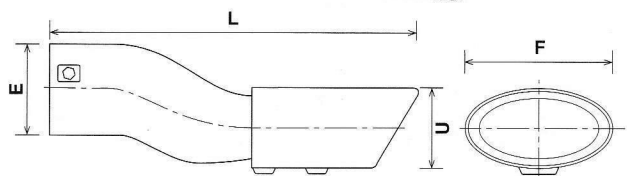
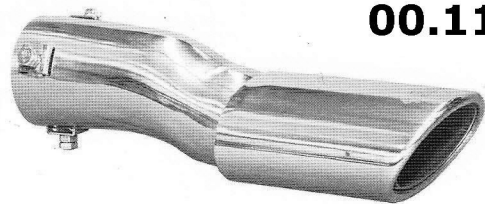
**00.110.83**

Dimensioni/Dimensions				
	E	F	U	L
mm.	58	101	57	254

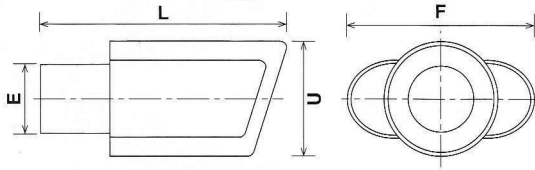
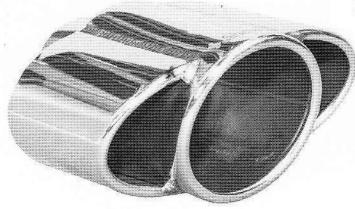

**01.110.84**

Dimensioni/Dimensions				
	E	F	U	L
mm.	58	165	89	176

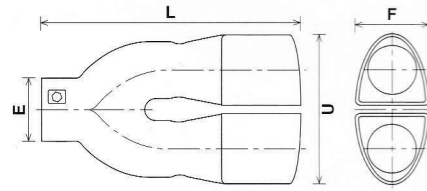
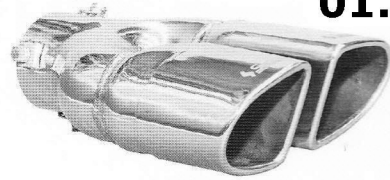
**01.110.85**

Dimensioni/Dimensions				
	E	F	U	L
mm.	58	71	145	220

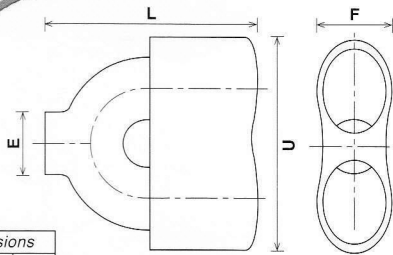
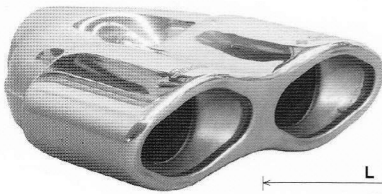
**01.110.86**

Dimensioni/Dimensions				
	E	F	U	L
mm.	58	70	198	202

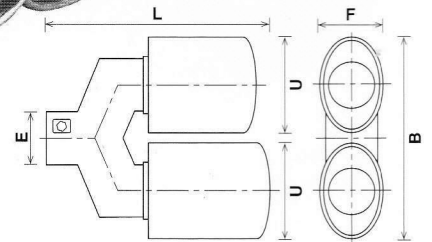
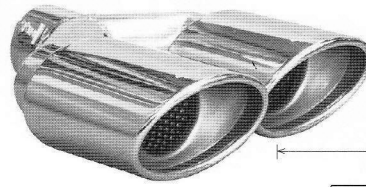
**00.110.87 DX  
(SILENZIATO)**

Dimensioni/Dimensions					
	E	F	U	L	B
mm.	51	70	107	230	214

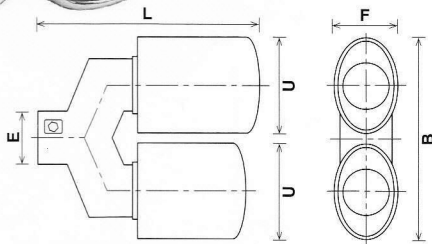
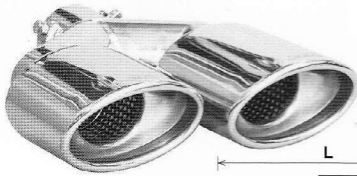
**01.110.88 SX  
(SILENZIATO)**

Dimensioni/Dimensions					
	E	F	U	L	B
mm.	51	70	107	230	214

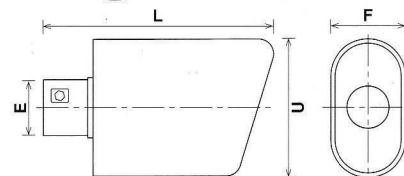
**01.110.89 DX**

Dimensioni/Dimensions				
	E	F	U	L
mm.	54	80	150	178

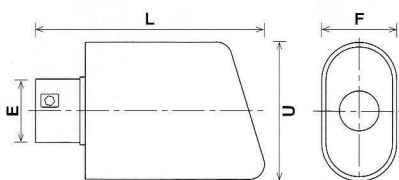
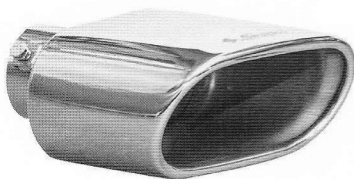
**01.110.90 SX**

Dimensioni/Dimensions				
	E	F	U	L
mm.	54	80	150	178

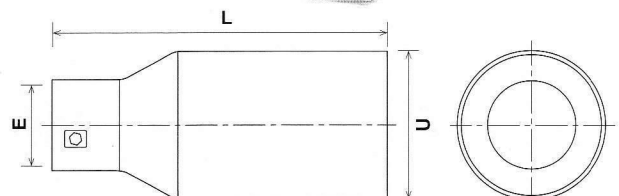
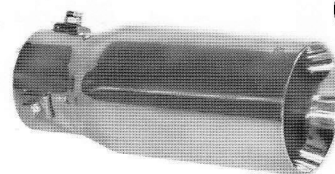
**01.110.91**

Dimensioni/Dimensions			
	E	U	L
mm.	58	114	178

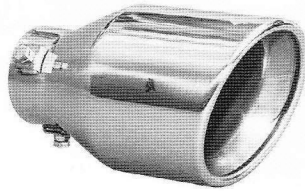

**01.110.92**

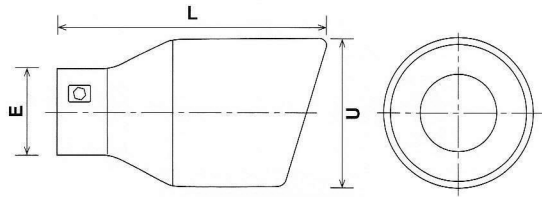

Dimensioni/Dimensions			
	E	U	L
mm.	58	114	178

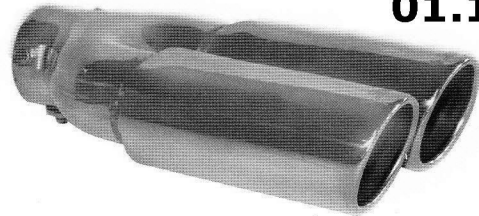

**01.110.93**

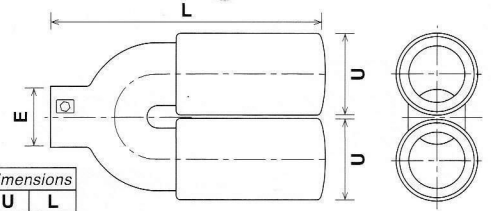

Dimensioni/Dimensions			
	E	U	L
mm.	58	76	225

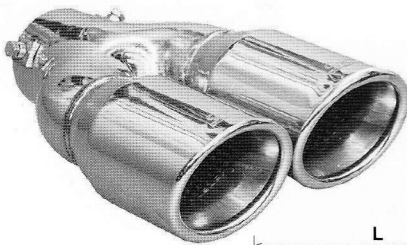

**00.110.94**  
(SILENZIATO)

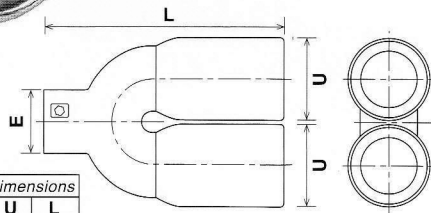

Dimensioni/Dimensions			
	E	U	L
mm.	58	76	225

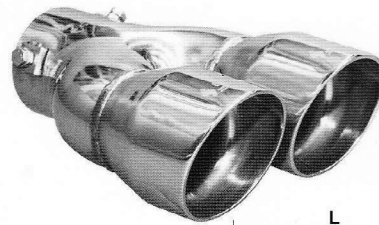

**00.110.95**

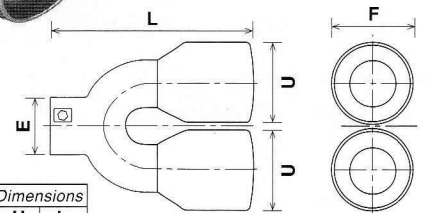

Dimensioni/Dimensions				
	E	U	L	F
mm.	58	76	195	

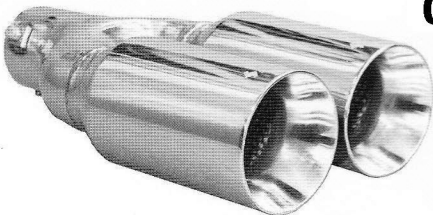

**00.110.96**  
(SILENZIATO)

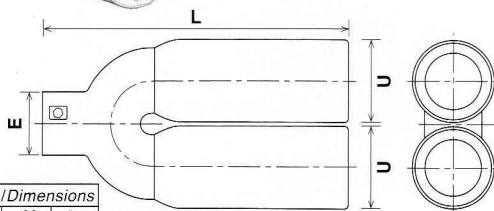

Dimensioni/Dimensions			
	E	U	L
mm.	58	89	305

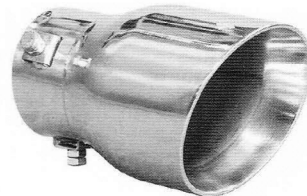

**00.110.97**

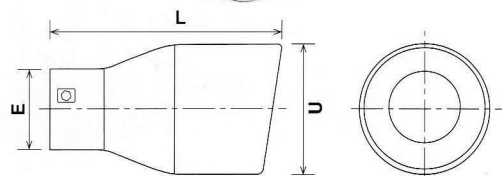

Dimensioni/Dimensions			
	E	U	L
mm.	58	89	140

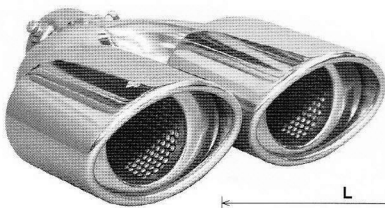

**00.110.98**  
(SILENZIATO)

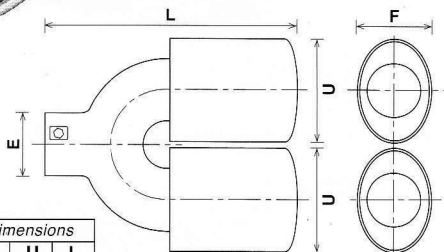

Dimensioni/Dimensions				
	E	F	U	L
mm.	58	85	117	256

# Fusti adattabili e accessori

**00.113.01**  
(FORATO ELICOIDALE)

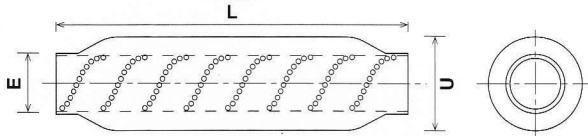
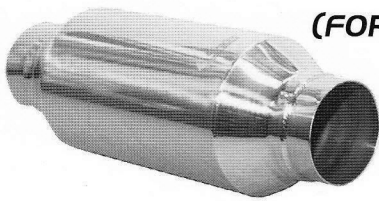

Dimensioni/Dimensions			
	E	U	L
mm.	61	101	300

**00.113.02**

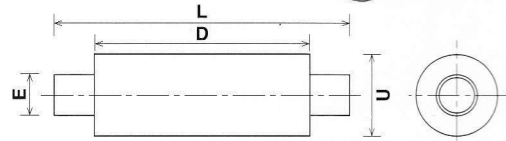
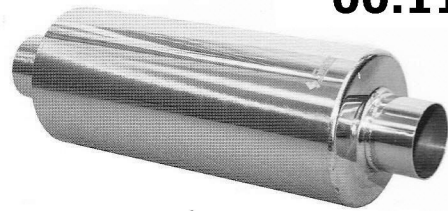

Dimensioni/Dimensions				
	E	U	D	L
mm.	58	127	300	410

**00.113.03**

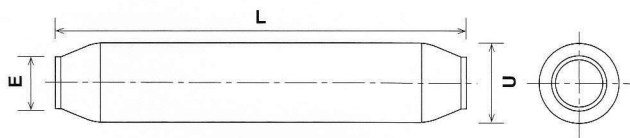
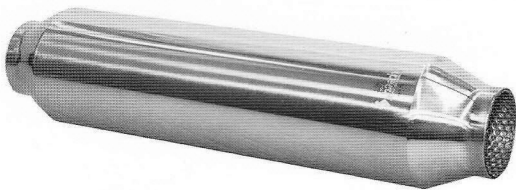

Dimensioni/Dimensions			
	E	U	L
mm.	60	102	450

**00.113.04**

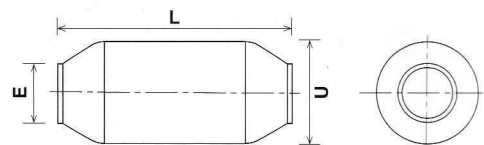
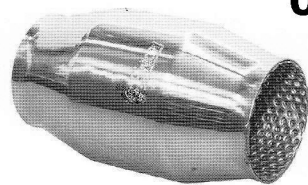

Dimensioni/Dimensions			
	E	U	L
mm.	61	89	150

**00.113.05**

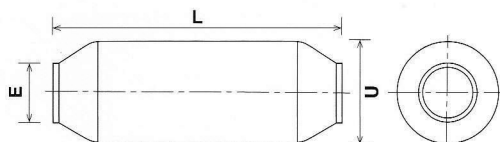
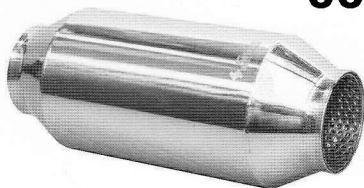

Dimensioni/Dimensions			
	E	U	L
mm.	61	101	254

**00.113.06**

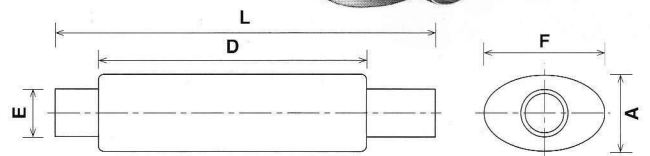
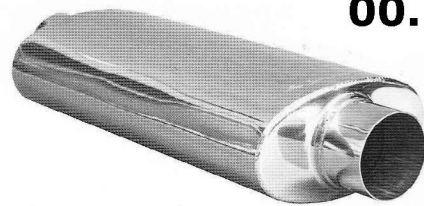

Dimensioni/Dimensions			
	E	F x A x D	L
mm.	61	162x89x445	550

**00.113.07**  
(SOSTITUZIONE CAT)

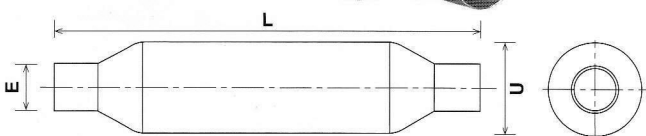

Dimensioni/Dimensions			
	E	U	L
mm.	58	89	420

**00.113.08**

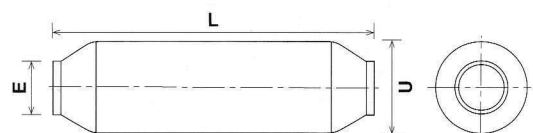
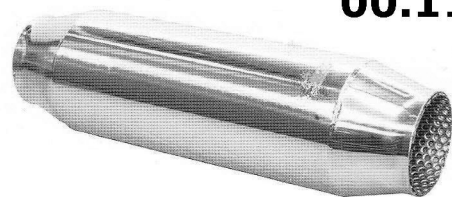

Dimensioni/Dimensions			
	E	U	L
mm.	61	89	300

**00.113.09**

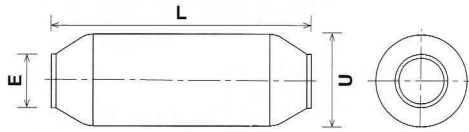
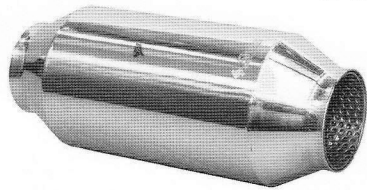

Dimensioni/Dimensions			
	E	U	L
mm.	61	101	300

**00.113.10**

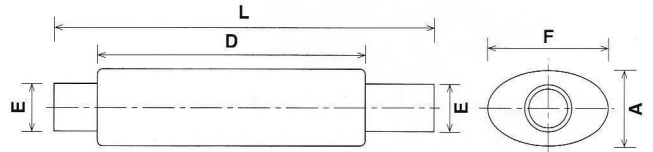
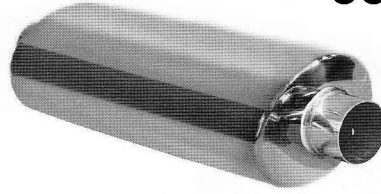

Dimensioni/Dimensions			
	E	F x A x D	L
mm.	70	203x127x335	508

**00.114.01**

**(BIFORCAZIONE PER MODIFICA)**

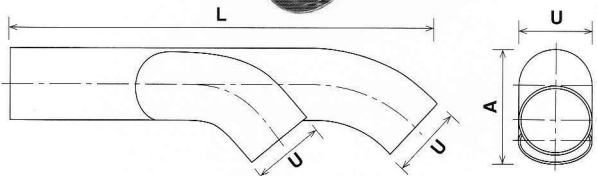
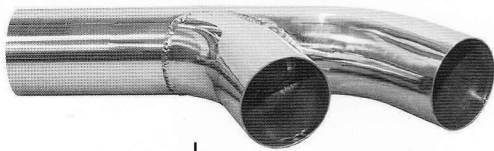

Dimensioni/Dimensions			
	A	U	L
mm.	74	76	400

**00.114.02**

**(MODIFICA PER FUORISTRADA)**

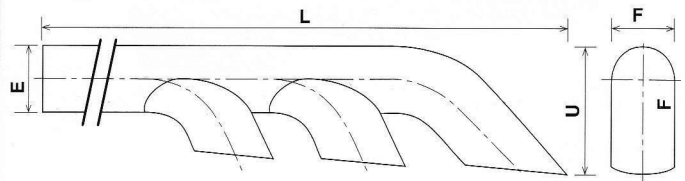
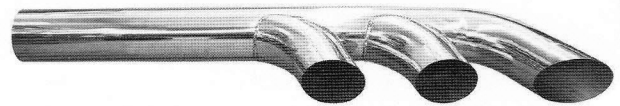

Dimensioni/Dimensions				
	E	F	U	L
mm.	76	76	132	601

**00.114.03**

**(BIFORCAZIONE PER MODIFICA)**

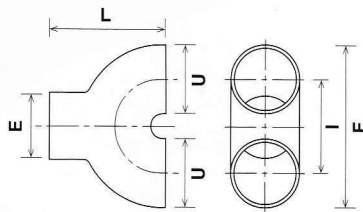
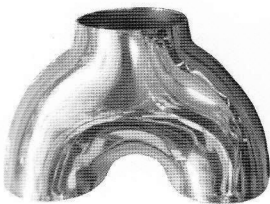

Dimensioni/Dimensions					
	E	F	U	L	I
mm.	58	160	58	100	105

**00.114.04**

**(BIFORCAZIONE PER MODIFICA)**

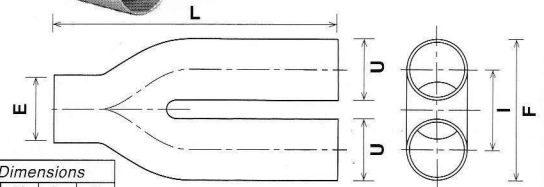

Dimensioni/Dimensions					
	E	F	U	L	I
mm.	50	130	50	200	85

**00.114.05**

**(MODIFICA PER AUTOCARRO)**

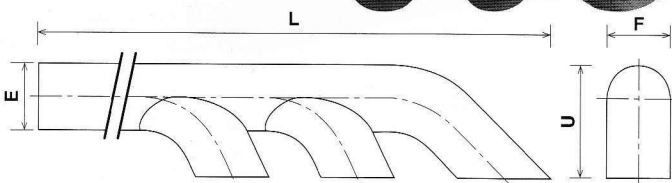
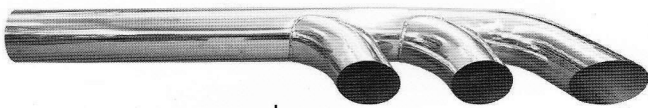

Dimensioni/Dimensions				
	E	F	U	L
mm.	102	102	178	775

# Silenziatori in acciaio per moto

**00.114.50**  
(CON KIT DI FISSAGGIO)

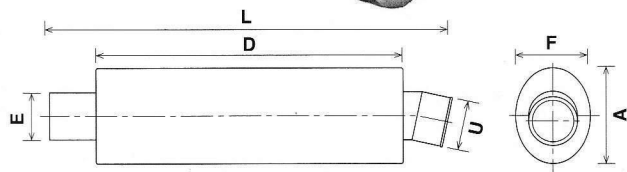

Dimensioni/Dimensions				
	E	F x A x D	L	U
mm.	58	96x127x355	455	60

**00.114.51**  
(CON KIT DI FISSAGGIO)

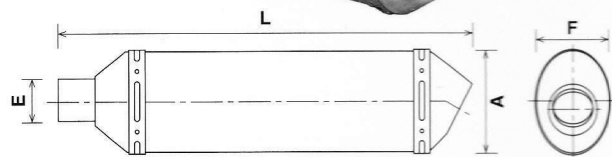

Dimensioni/Dimensions			
	E	F x A	L
mm.	58	125x95	470